



HOGARES

NUEVA GAMA
NOUVELLE GAMME
NOVA GAMA

VISION



VISION

ESP

NUNCA VERÁS MEJOR LA BELLEZA DEL FUEGO

Fugar Chimeneas diseña y produce hogares, chimeneas y una extensa gama de productos del fuego-hogar. Aquí te presentamos nuestra nueva gama de hogares VISION.

FRA

VOUS N'APPRÉCIEZ JAMAIS AUTANT LA BEAUTÉ DU FEU
Fugar conçoit et fabrique une large gamme de foyers et de cheminées. Nous vous présentons ici notre nouvelle gamme de foyers VISION.

POR

NUNCA VERÁS MELHOR A BELEZA DO FOGO

Fugar desenha e produz lareiras, chaminés e uma extensa gama de produtos de fogo do lar. Aqui apresentamos-lhe a nossa nova gama de lareiras VISION.



LA VISIÓN TOTAL DE LA CALIDEZ
 LA VISION GLOBALE DE LA CHALEUR
 A VISÃO TOTAL DA CALIDEZ

LA NUEVA GAMA VISION PRESENTA: Una nueva estructura de acero que ofrece mayor flexibilidad para resistir el choque térmico sin riesgo de fisuras, elementos móviles e intercambiables que garantizan su durabilidad, nuevas versiones y su personalización que la definen como la gama más versátil e innovadora.

LA NOUVELLE GAMME VISION PRÉSENTE: Une nouvelle structure en acier qui offre une flexibilité résistant au choc thermique sans risque de fissures, éléments mobiles et interchangeables qui garantissent la durabilité, nouvelles versions et sa personnalisation qui la définissent comme la gamme la plus diversifiée et innovante.

A NOVA GAMA VISION PRESENTA: Nova estrutura de aço que oferece maior flexibilidade resistente ao choque térmico sem risco de fisuras, elementos móveis e intercambiáveis que garantizam a sua durabilidade, novas versões e a sua personalização a definem como a gama mais versátil e inovadora.

► **VISION 3 CARAS 67 PLUS**



TRES CARAS PLUS presenta una característica: apertura de sus cristales laterales, independientemente de su sistema escamoteable vertical.

TRES CARAS PLUS présente une caractéristique: ouverture de leurs vitres latérales, indépendamment de son système escamotable vertical.

TRES CARAS PLUS apresenta uma característica: abertura dos seus vidros laterais, independentemente do seu sistema escamoteável vertical.

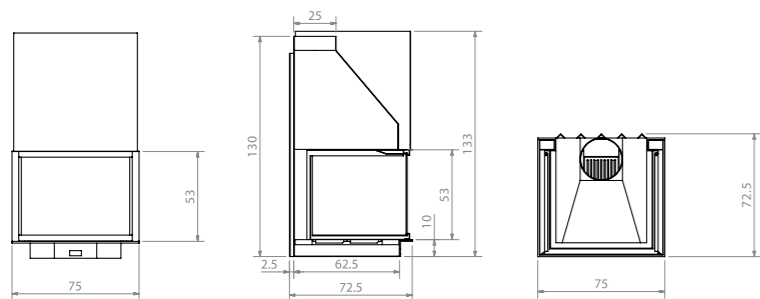



CUANDO EL FUEGO SE MULTIPLICA POR 3
QUAND LE FEU EST MULTIPLIÉ PAR 3
QUANDO O FOGO SE MULTIPLICA POR 3

▼ **VISION 3 CARAS 67**

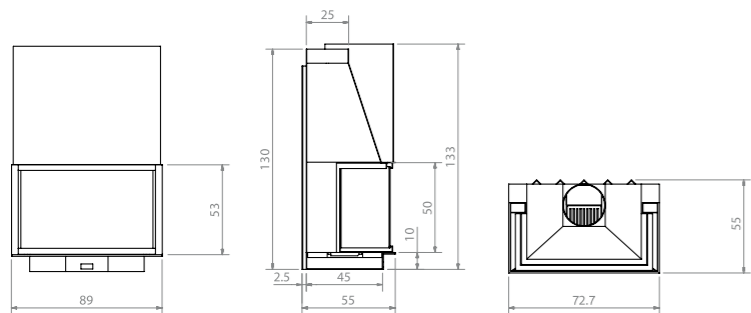

▼ **VISION 3 CARAS 105**

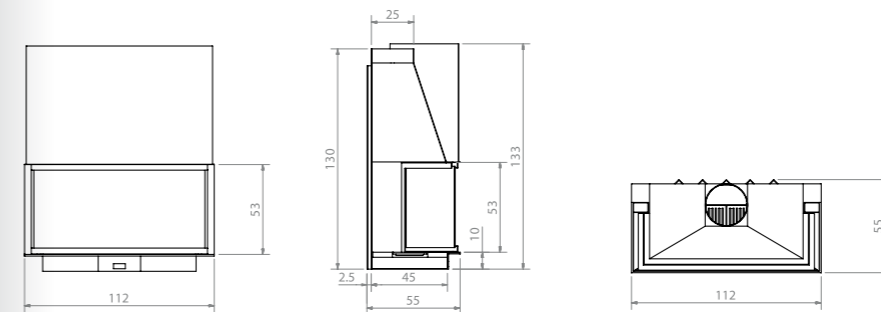

▼ **VISION FRONTAL 90**

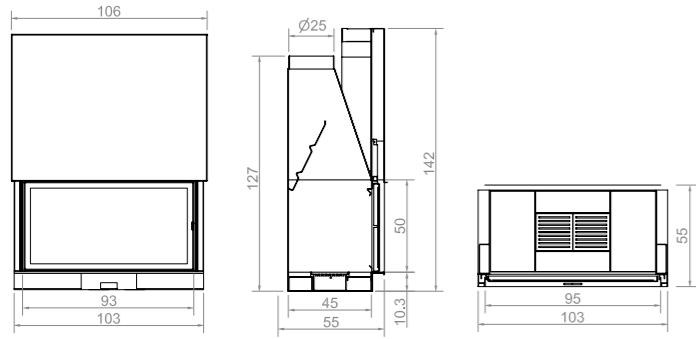

▼ **VISION FRONTAL 67**

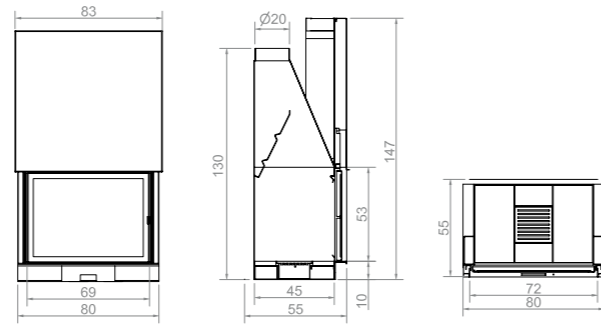

▼ **VISION FRONTAL 105**

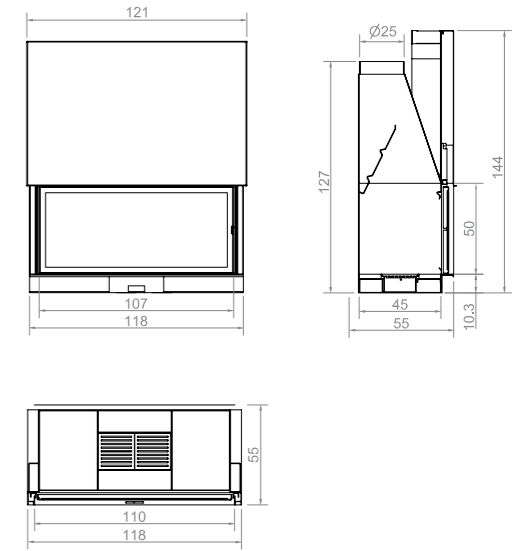

▼ **VISION FRONTAL 120**

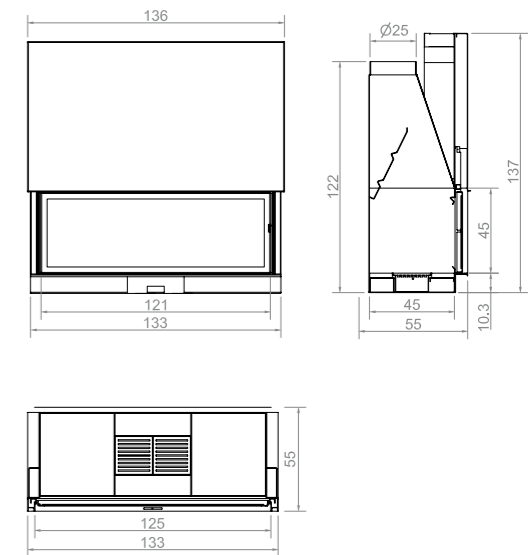



NUESTRA OFERTA PARA EL MEJOR RINCÓN
NOTRE OFFRE POUR LE MEILLEUR EMPLACEMENT
A NOSSA OFERTA PARA O MELHOR RECANTO

▼ **VISION LATERAL 105**

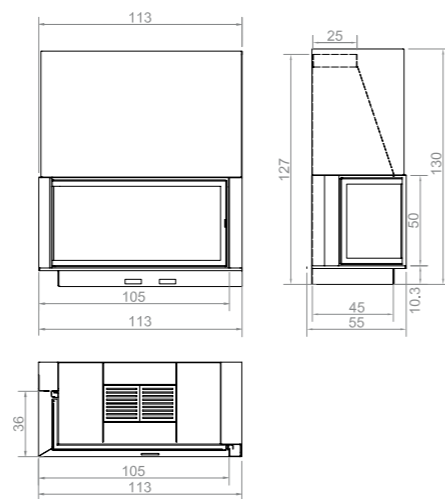

▼ **VISION LATERAL 67**

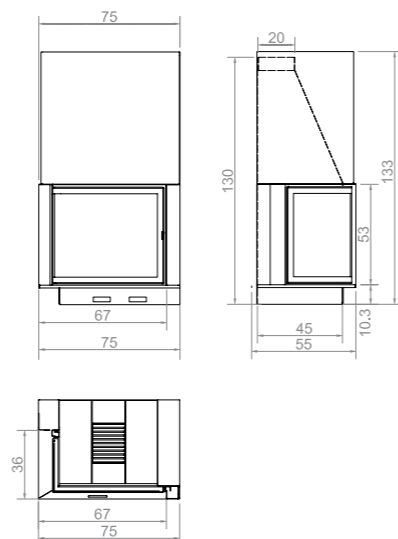

▼ **VISION LATERAL 115**

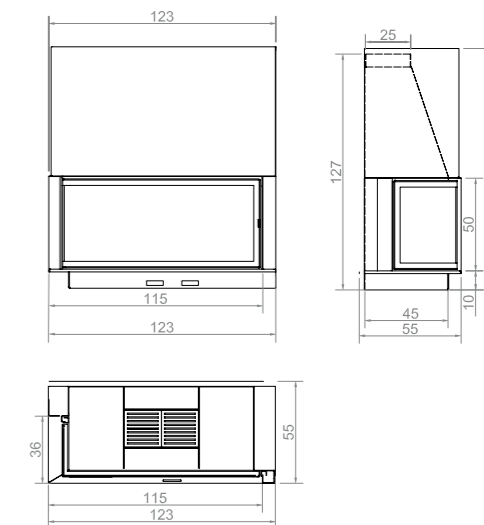

▼ **VISION LATERAL 90**

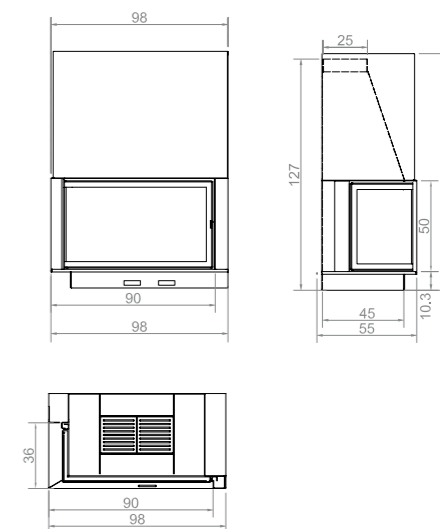



VISIÓN Y FUNCIONALIDAD UNIDOS POR LA UBICACIÓN
VISION ET FONCTIONNALITÉ RÉUNIS EN UN MÊME ENDROIT
 VISÃO E FUNCIONALIDADE UNIDOS PELA LOCALIZAÇÃO

▼ **VISION 2 BOCAS 105**

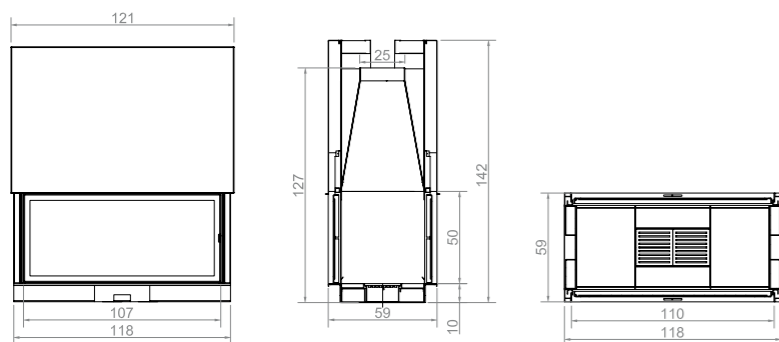

▼ **VISION 2 BOCAS 90**

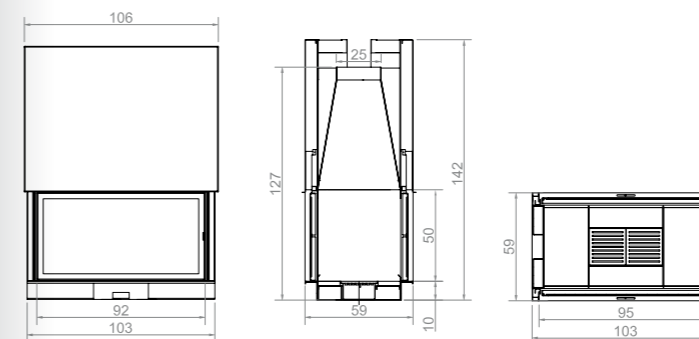

VISION 2 BOCAS 67

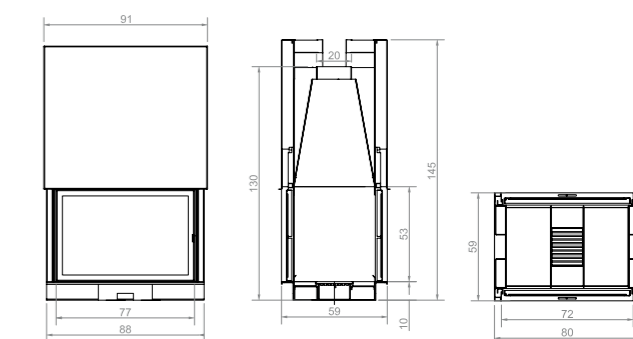



MEDIDAS PARA EL EQUILIBRIO VISUAL
 MESURES POUR L'ÉQUILIBRE VISUEL
 MEDIDAS PARA O EQUILIBRIO VISUAL

▼ **VISION SCENIC**

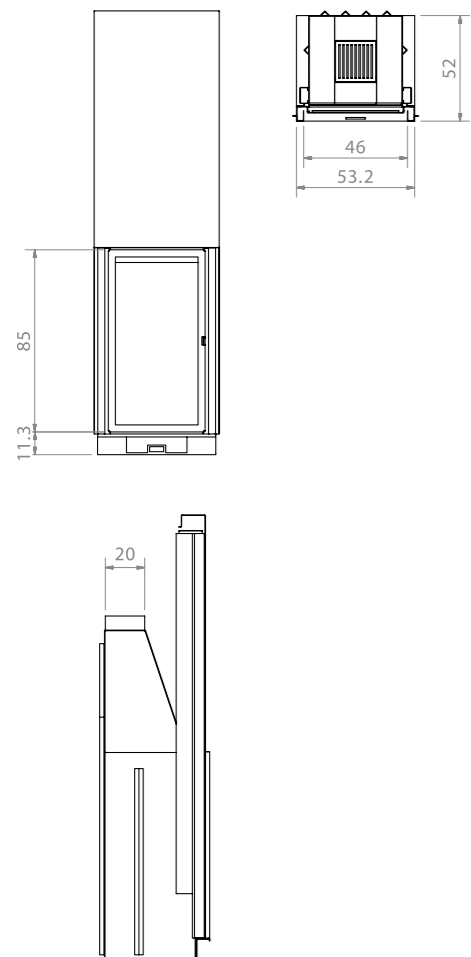

FUERA DE SERIE
 HORS SÉRIE
 FORA DE SERIE

La realización a medida es nuestro mejor y mayor diferencial.
La réalisation sur mesure est notre meilleure et plus grande différence.
 A realização à medida é o nosso melhor e maior diferencial.

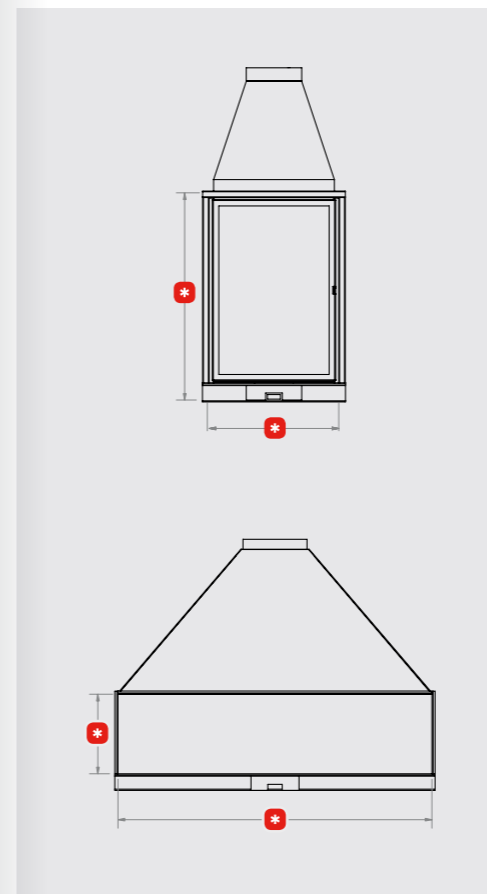



FUGAR Chimeneas

Ctra. Sant Pau, s/n Apdo.14,
08540 - Centelles, Barcelona (España)
T (+34) 93 881 37 07 · F (+34) 93 881 26 53
fugar@fugar.com
www.fugar.com